

Clean air...it's what we do

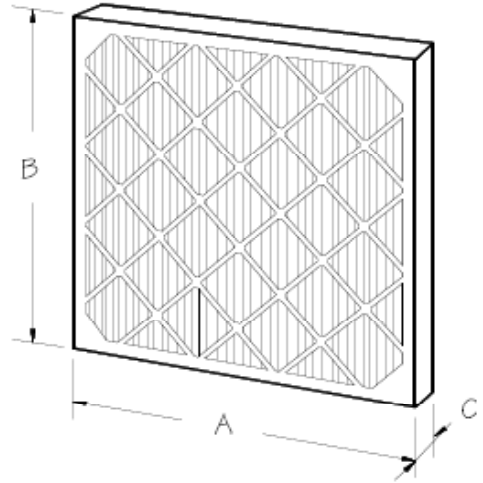

Specifications

Frame: 100% polypropylene plastic board.

Media: 100% polypropylene fibers, water and bacteria resistant.

Media is spaced and supported with beads of polypropylene polymer.

Media bonded to frame using polypropylene adhesive.

Efficiency: 80-85% per ASHRAE 52.1; MERV 13 per ASHRAE 52.2

UL 900: Class 2

Mini Pleat - 2" Nominal Depth, 80%-85%, MERV 13

Model Number	Width "A"	Height "B"	Depth "C"
AFMP85-24242-**	23-3/8"	23-3/8"	1-7/8"
AFMP85-20252-**	19-1/2"	24-1/2"	1-7/8"
AFMP85-20242-**	19-1/2"	23-3/8"	1-7/8"
AFMP85-20202-**	19-1/2"	19-1/2"	1-7/8"
AFMP85-16252-**	15-1/2"	24-1/2"	1-7/8"
AFMP85-16202-**	15-1/2"	19-1/2"	1-7/8"
AFMP85-12242-**	11-3/8"	23-3/8"	1-7/8"

**Insert DF for die cut frame or PF for polypropylene

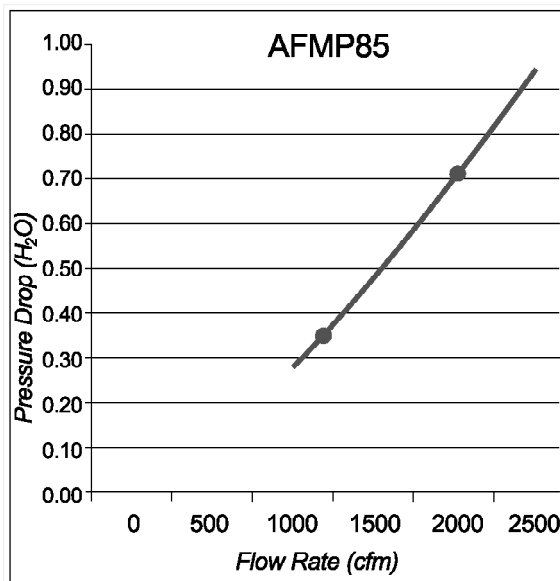

PO Box 2205 Ph: 919-718-5818
 Sanford, NC 27331 Fax: 919-718-5819
 info@airscrubbersinc.com

**Mini Pleat, 2" Nominal Depth
 80%-85% MERV 13**

Date 01/02/10

Model

Revision

AFMP85-2